

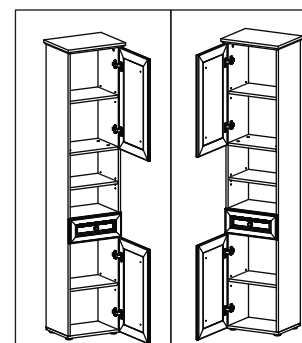

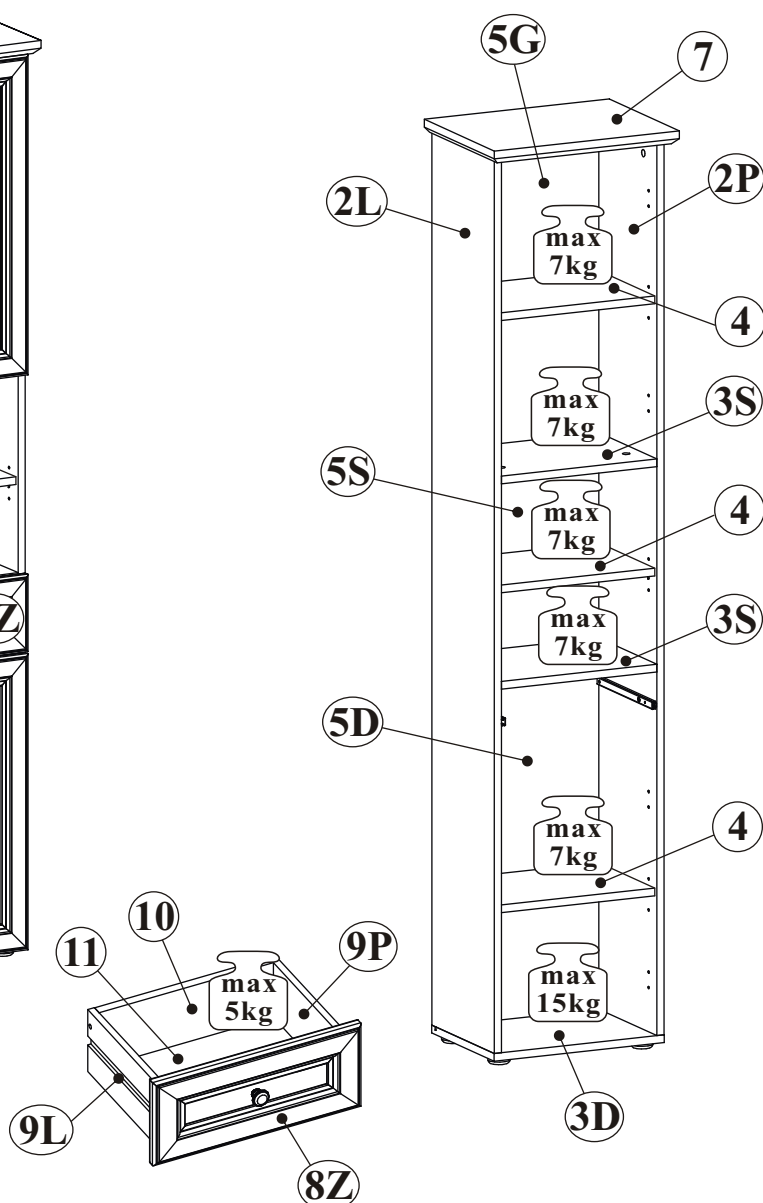

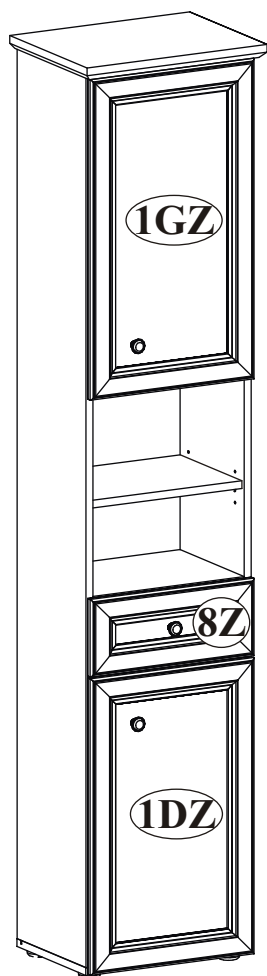

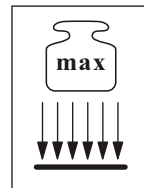

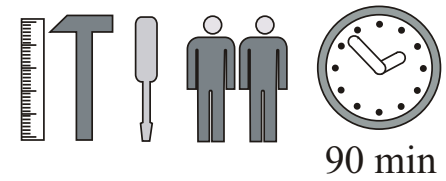

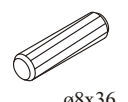
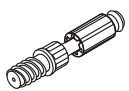



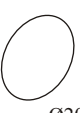
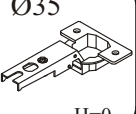
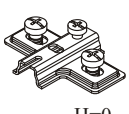

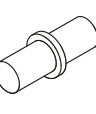



TOSKANA 70-648-__

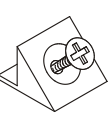
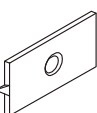

| NO | Dim. | | | Col.-No | Qty |
|-----|------|-----|----|---------|-----|
| 1DZ | 612 | 376 | 22 | 1 | 1 |
| 1GZ | 662 | 376 | 22 | 1 | 1 |
| 2L | 1840 | 284 | 16 | 1 | 1 |
| 2P | 1840 | 284 | 16 | 1 | 1 |
| 3D | 381 | 284 | 16 | 1 | 1 |
| 3S | 348 | 264 | 16 | 1 | 2 |
| 4 | 348 | 254 | 16 | 1 | 3 |
| 5D | 763 | 360 | 3 | 1 | 1 |
| 5S | 423 | 360 | 3 | 1 | 1 |
| 5G | 666 | 360 | 3 | 1 | 1 |
| 7 | 414 | 319 | 28 | 1 | 1 |
| 8Z | 376 | 160 | 22 | 1 | 1 |
| 9L | 250 | 120 | 12 | 1 | 1 |
| 9P | 250 | 120 | 12 | 1 | 1 |
| 10 | 315 | 106 | 16 | 1 | 1 |
| 11 | 255 | 326 | 3 | 1 | 1 |

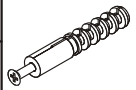
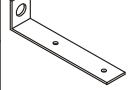

TOSKANA 70-648-__

| | | | | | |
|--|--|--|--|--|--|
| A1 x20  ø8x36 | B4 x14  | B5 x12  ø15x12 | G5 x12  | B7 x2  Ø15x10,3 | G8 x2  Ø20 |
| E21 x4 Ø35 H=0  | E2 x4 H=0  | D10 x11 USØ3,5x13  | G7 x11  | B11 x6 Ø7x50  | G4 x6  |
| H6 x1 L-250mm.  | D18 x2 M4x9  | D20 x4 ESØ6,3x9,5  | UG x3  | UP15 x3 UPØ4x25  | Z2 x10 Ø5  |
| S1 x15  | G16 x6  | UP13 x10 UPØ3x16  | I11 x4 Ø45, h=15  | UP11 x4 UPØ4x20  | G2 x1  |
| KR1 x1  | L1 x1  | PH x1  | | | |

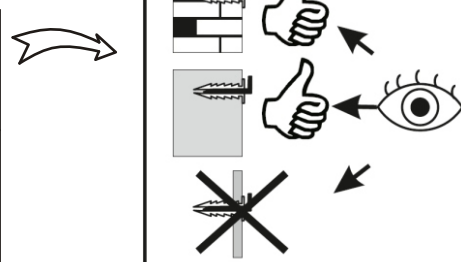
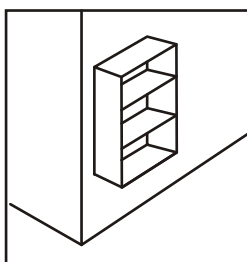
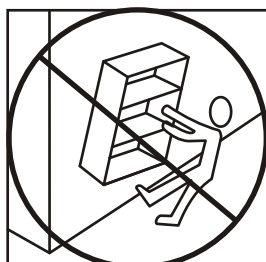
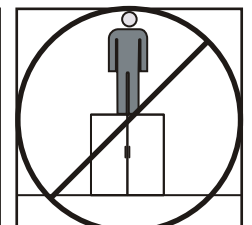
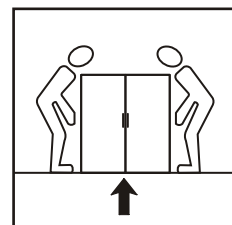
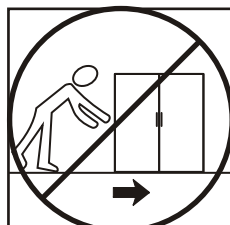
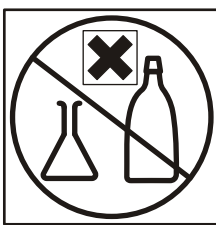
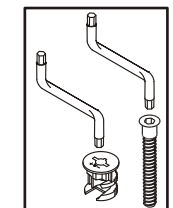
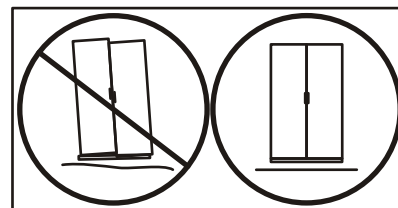
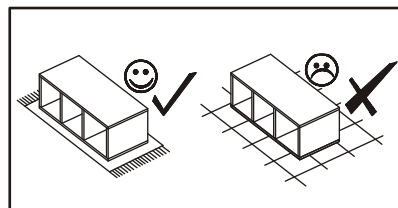
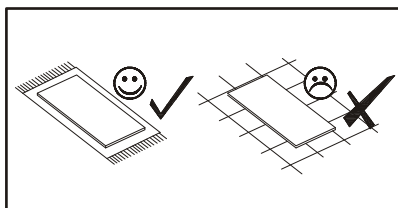
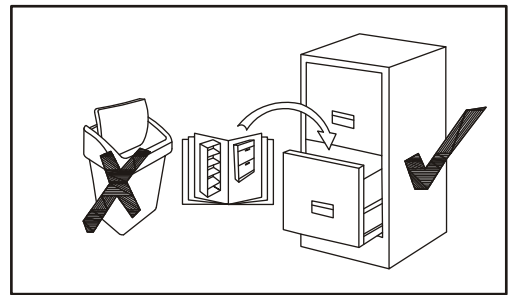
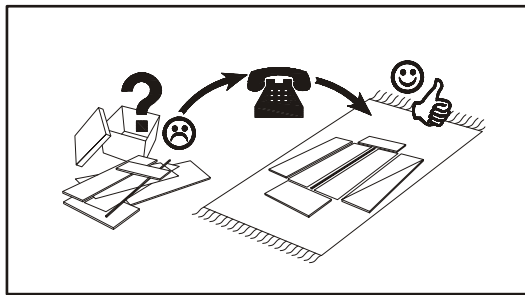
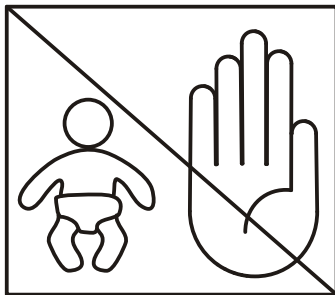
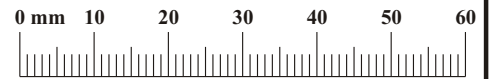

1

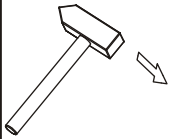

| | |
|----|-------|
| A1 | |
| x8 | ø8x36 |

| | |
|----|--|
| B4 | |
| x8 | |

| | |
|----|--------|
| B5 | |
| x4 | ø15x12 |

| | |
|----|--|
| PH | |
| x1 | |

| | |
|----|----------|
| H6 | |
| x1 | L-250mm. |

| | |
|-----|------------|
| D20 | |
| x4 | ESØ6,3x9,5 |

| | |
|-----|--|
| G7 | |
| x11 | |

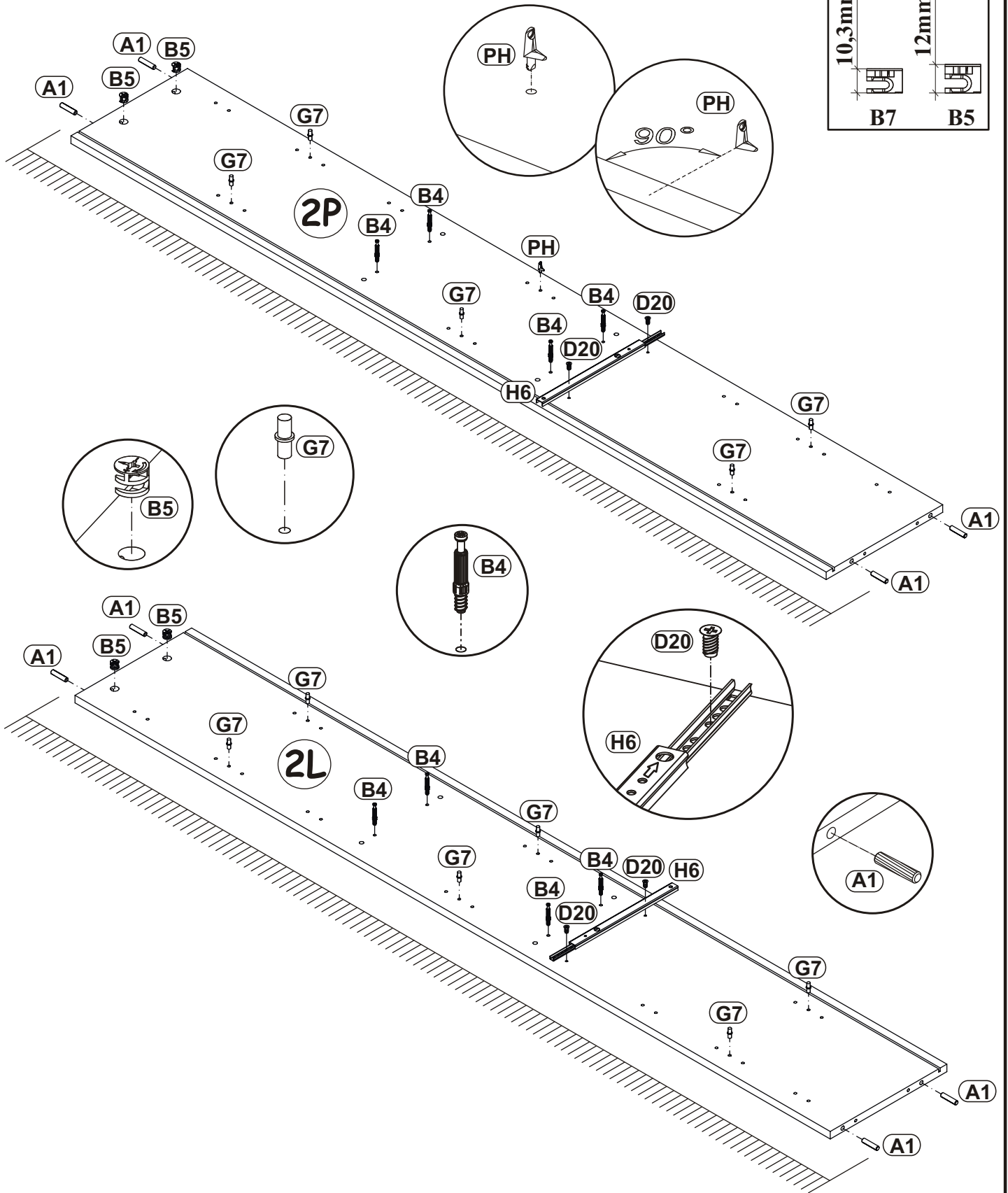
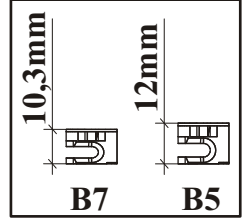

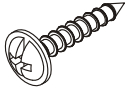
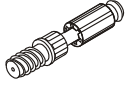

| | | | | | |
|-----|--|------|---|----|---|
| I11 |  | UP11 |  | B4 |  |
| x4 | Ø45, h=15 | x4 | UPØ4x20 | x4 | |

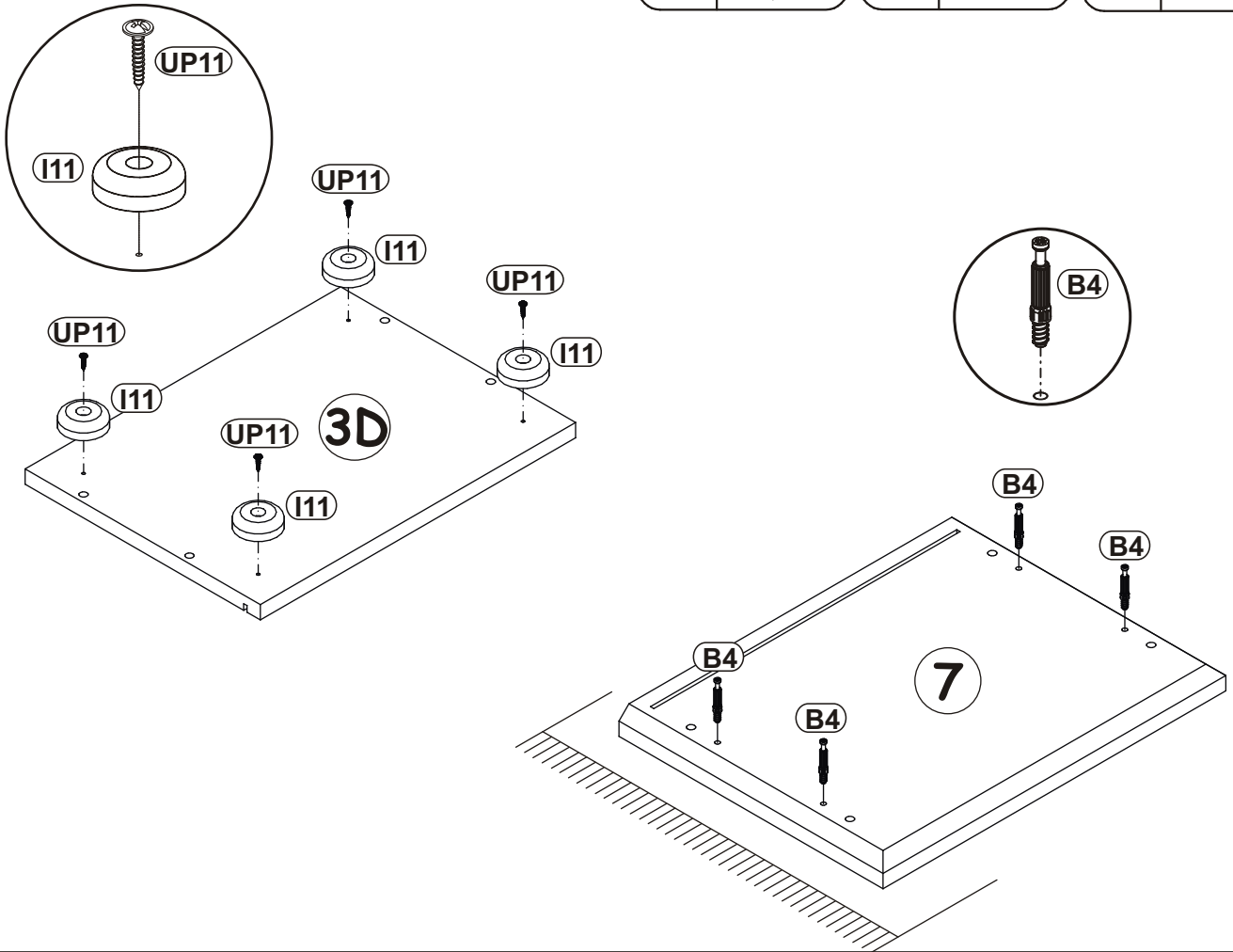
2

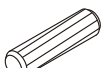

3

| | | | |
|----|---|----|---|
| A1 |  | B5 |  |
| x8 | ø8x36 | x8 | ø15x12 |

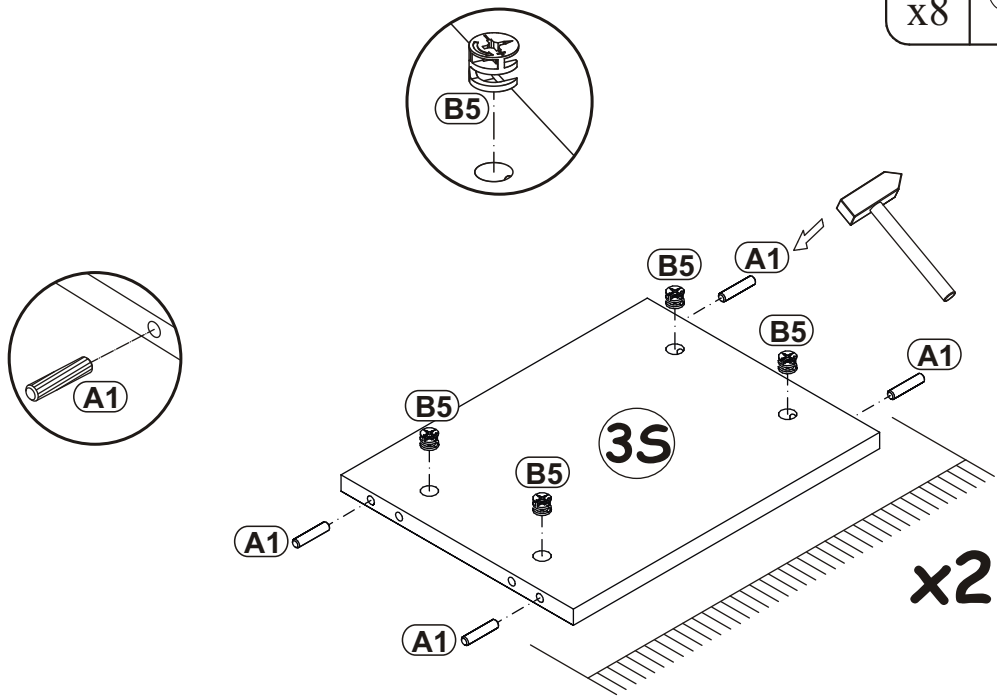

4

E21

Ø35

D10

x4

H=0

x8

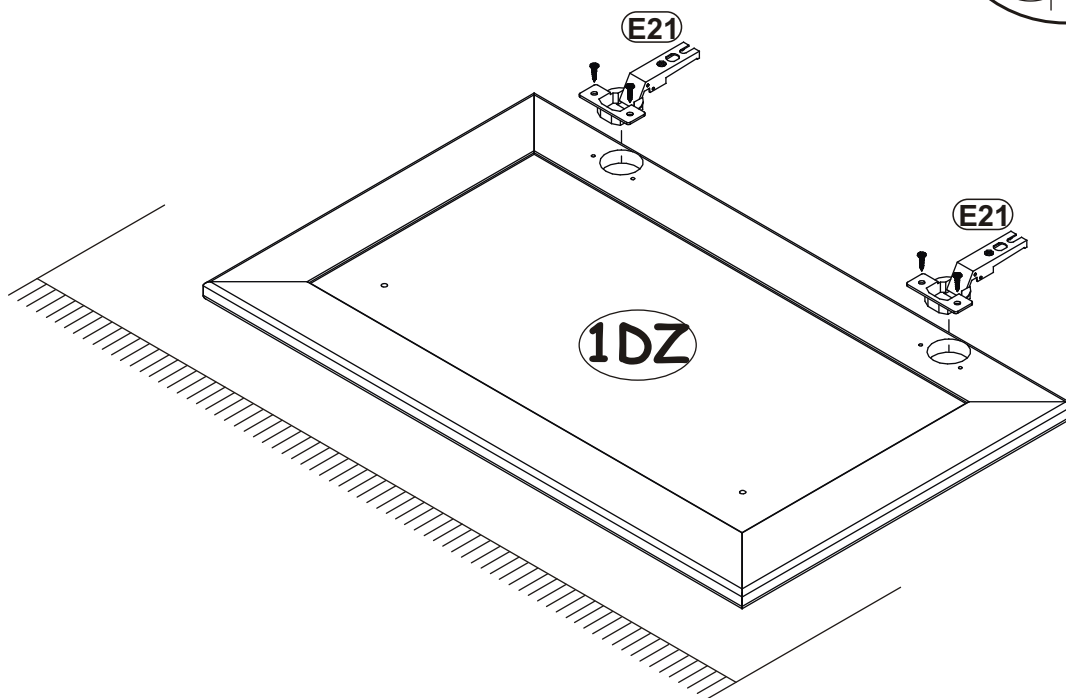
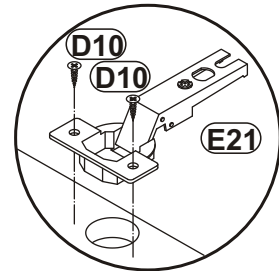
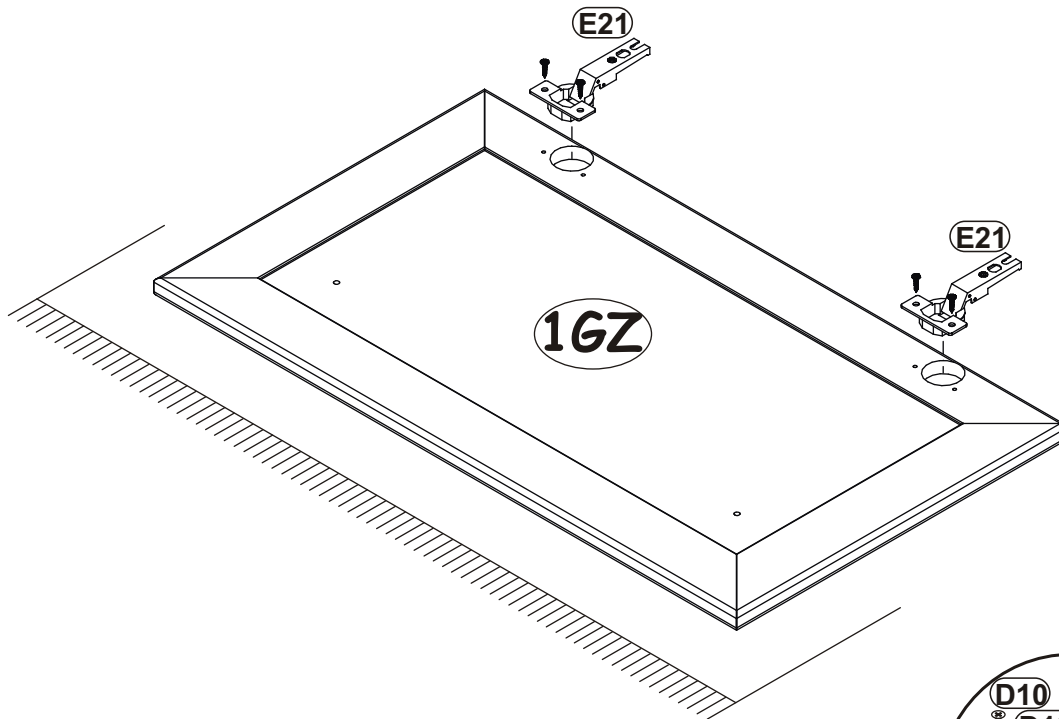

5

B4

x2

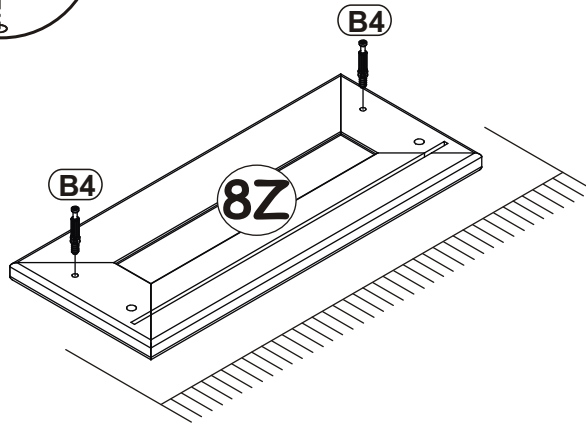
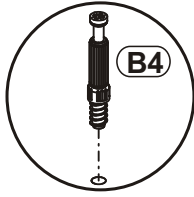
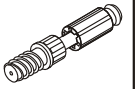

6

A1

x4



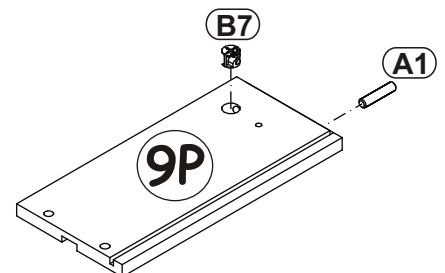
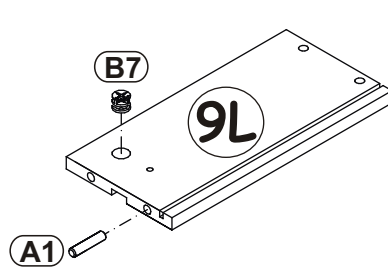
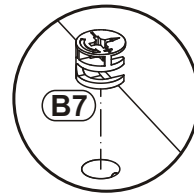
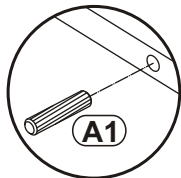
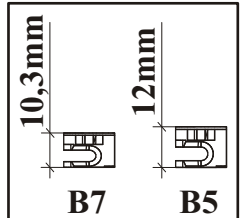
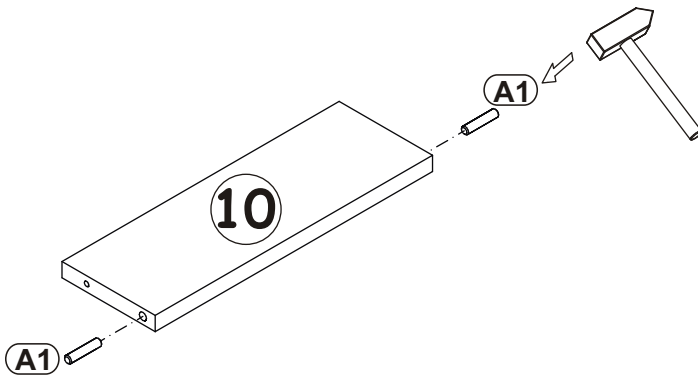

B7

x2



7

| | | | |
|-----|---|----|---|
| B11 |  | G4 |  |
| x2 | Ø7x50 | x2 | |

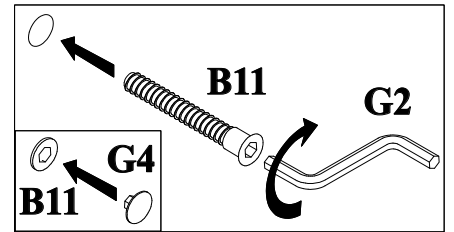
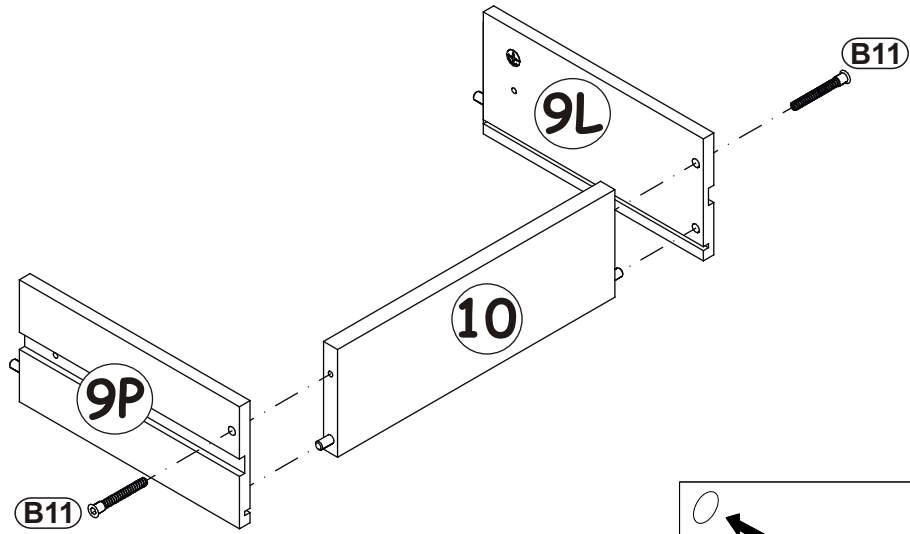

8

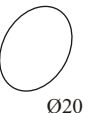
| | |
|----|---|
| G8 |  |
| x2 | Ø20 |

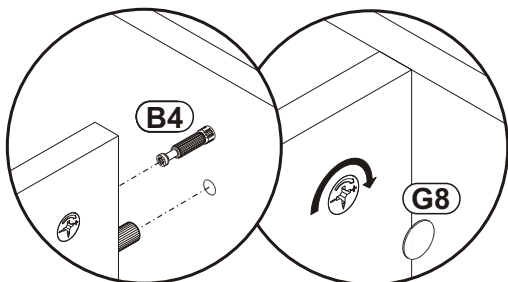
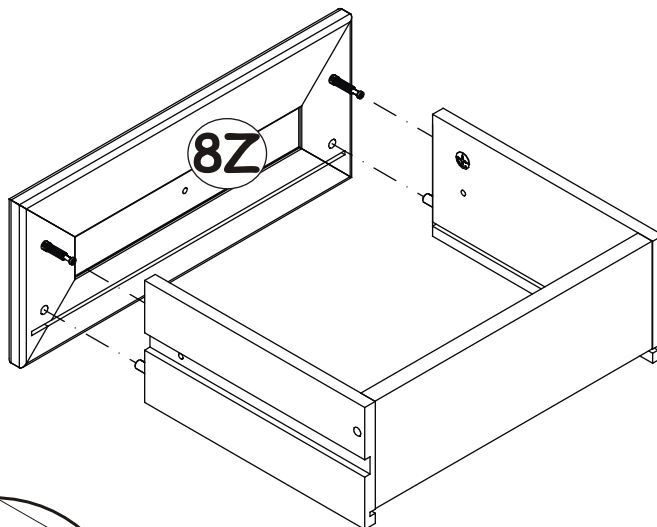

9

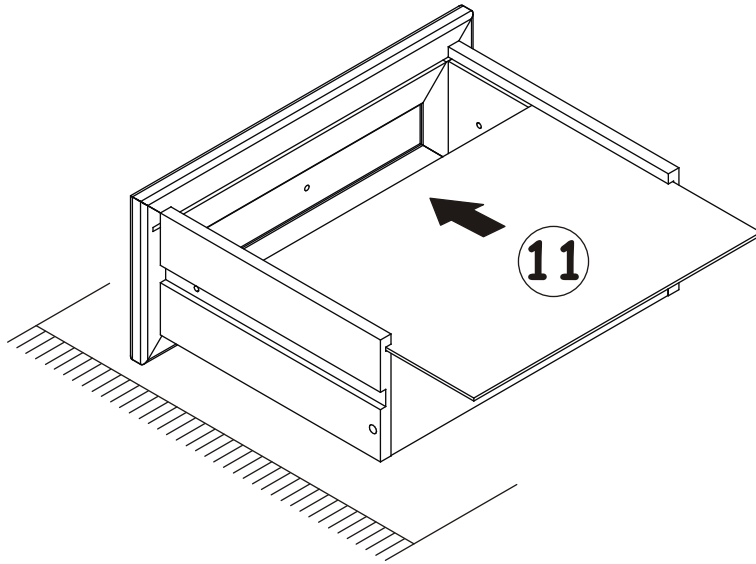

10

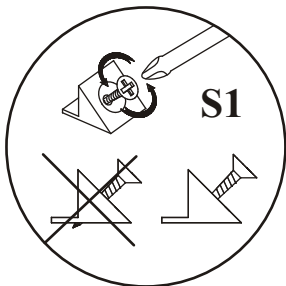

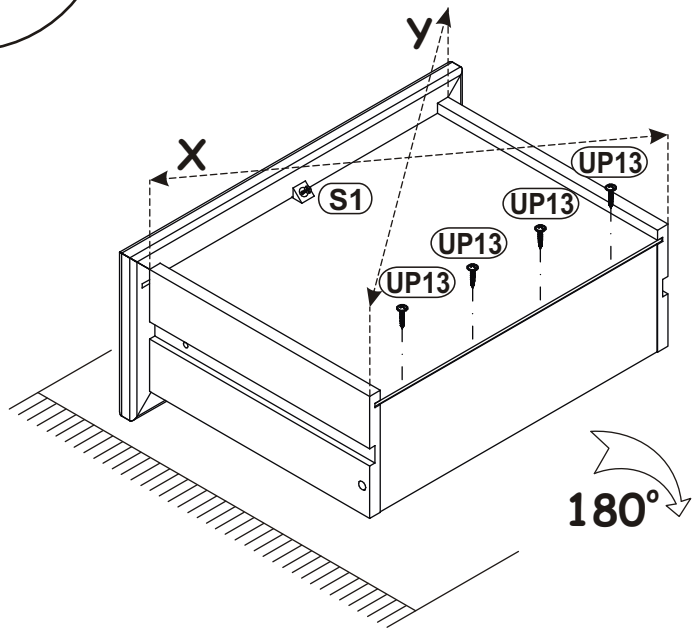

$X=y$ 90°

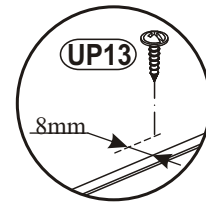

| | | | |
|----|--|------|---------|
| S1 | | UP13 | |
| x1 | | x4 | UPØ3x16 |



| | | | |
|----|---|------|--|
| UG |  | UP15 |  |
| x1 | | x1 | UP04x25 |

11

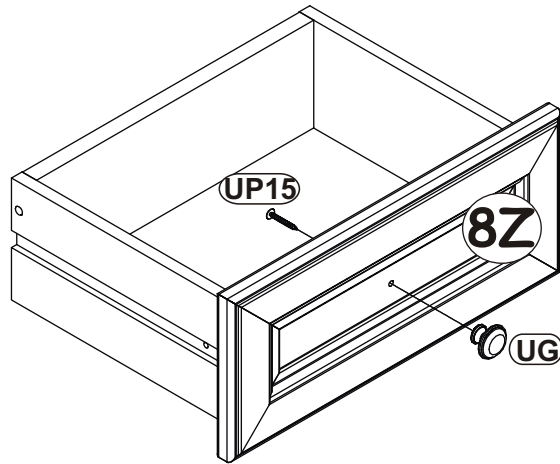

12

| | |
|----|---|
| G5 |  |
| x8 | |

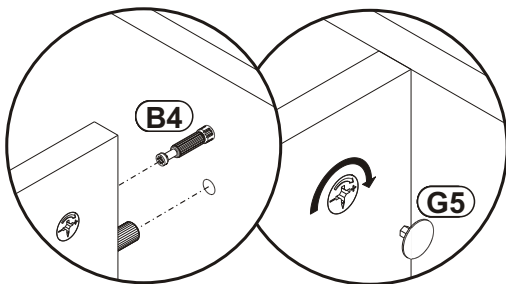
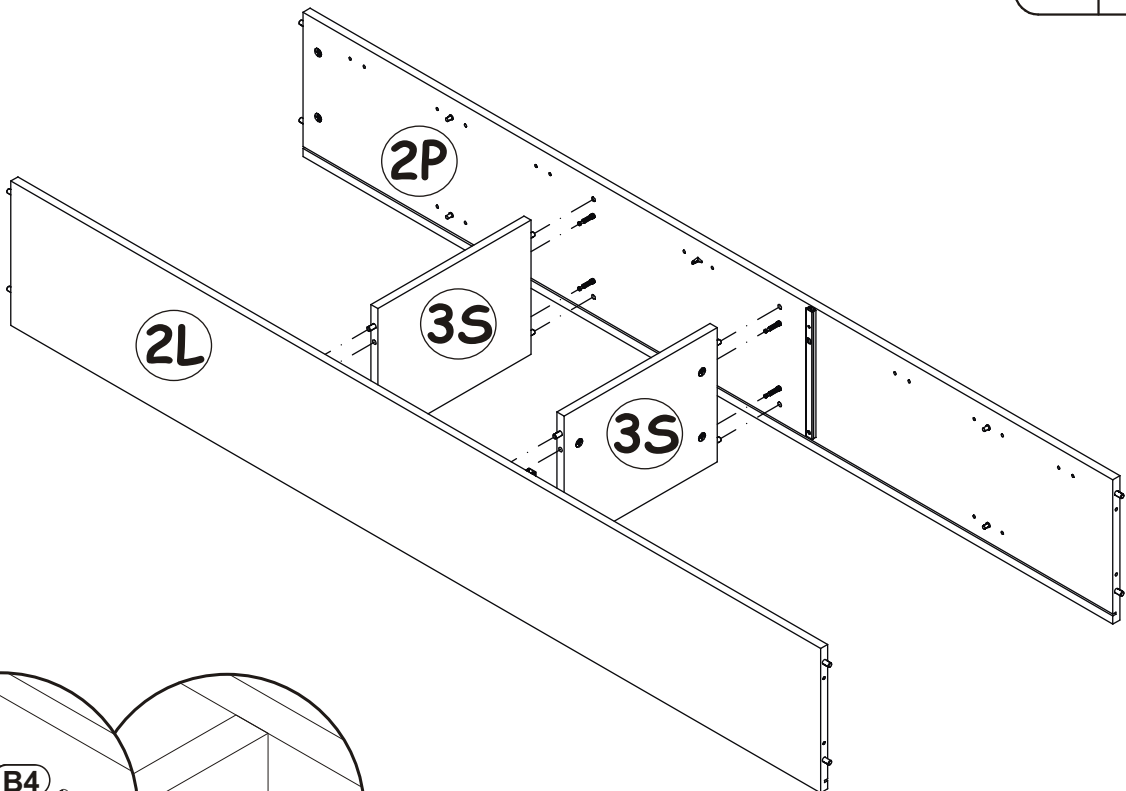

| | |
|-----|---|
| B11 |  |
| x4 | Ø7x50 |

| | |
|----|---|
| G4 |  |
| x4 | |

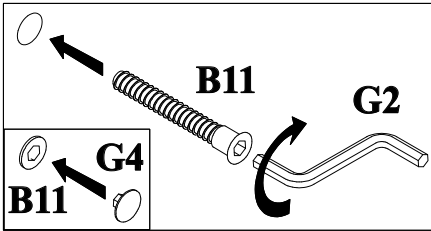
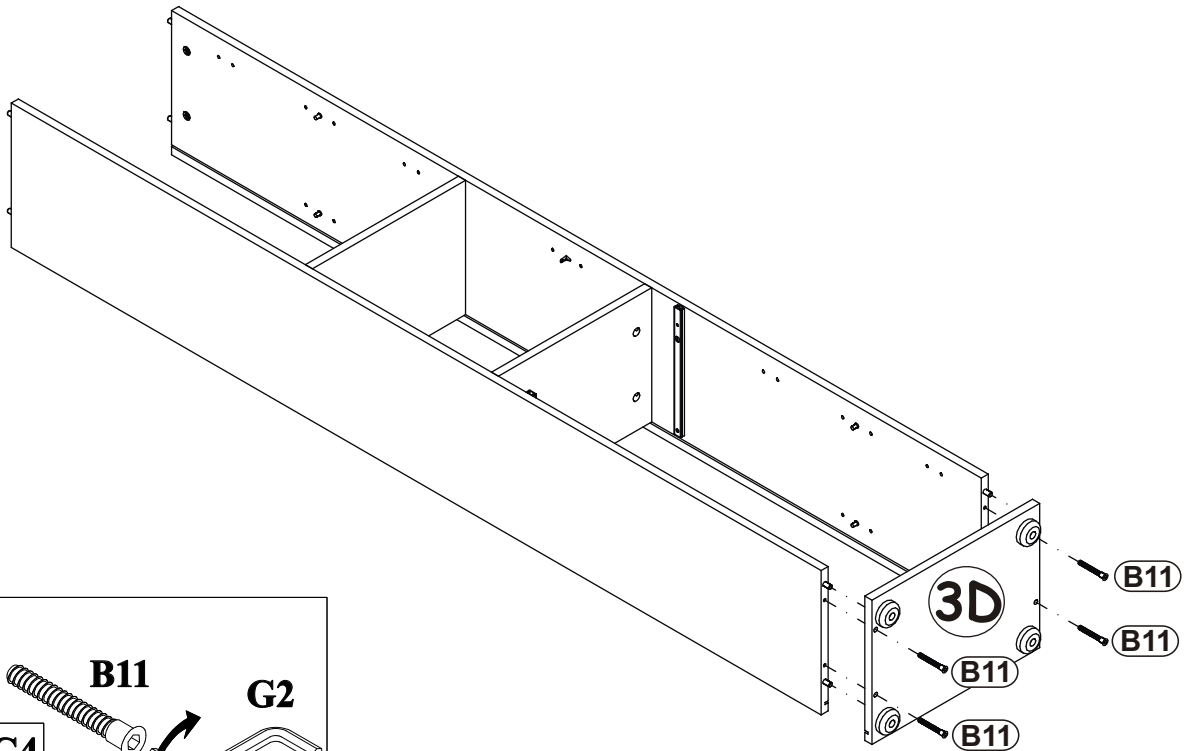

13

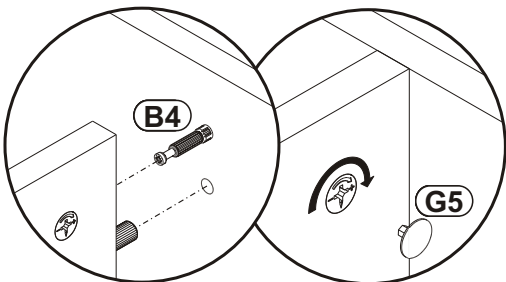
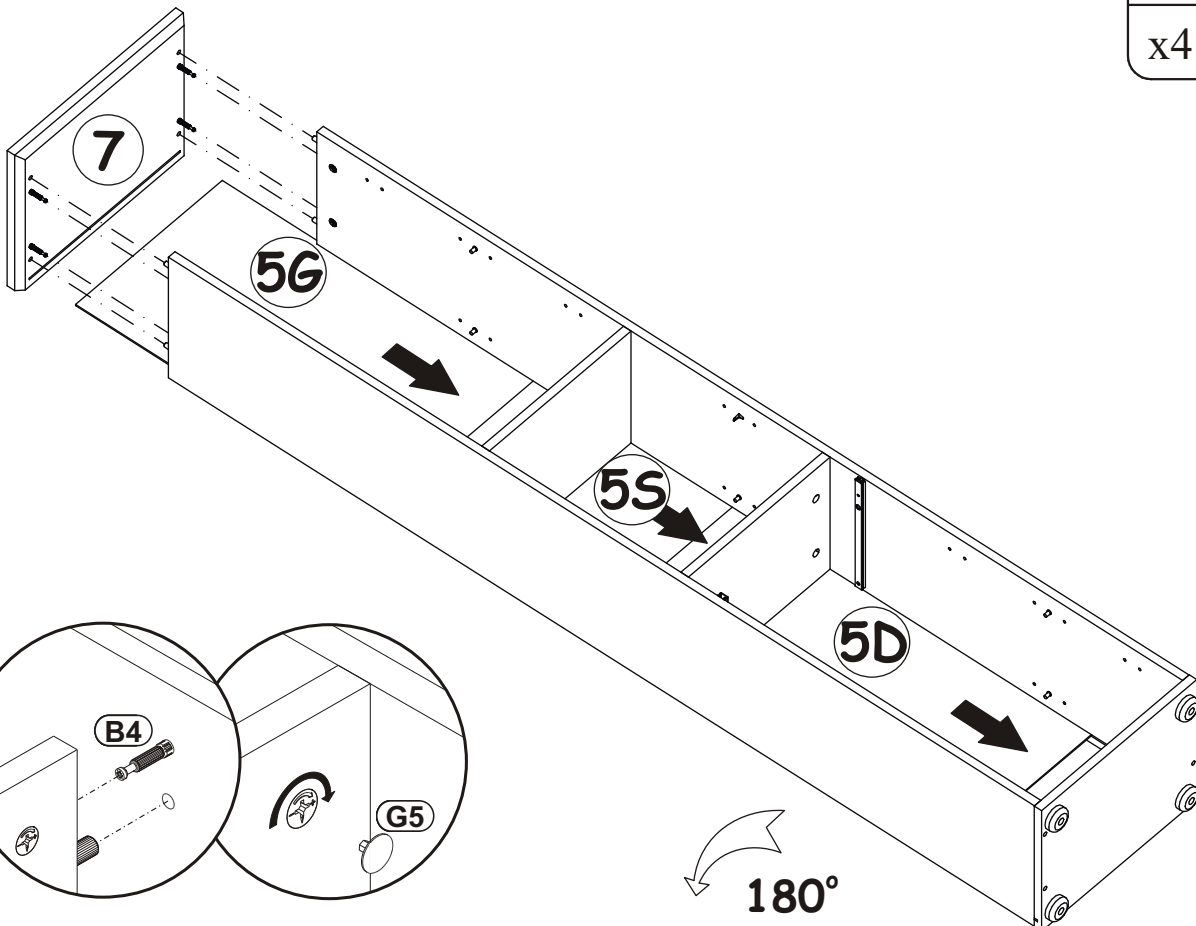

14

| | |
|----|---|
| G5 |  |
| x4 | |

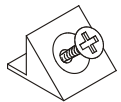
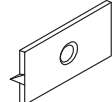

| | | | | | |
|-----|--|-----|---|------|---|
| S1 |  | G16 |  | UP13 |  |
| x14 | | x6 | | x6 | UPØ3x16 |

15

X=y 90°

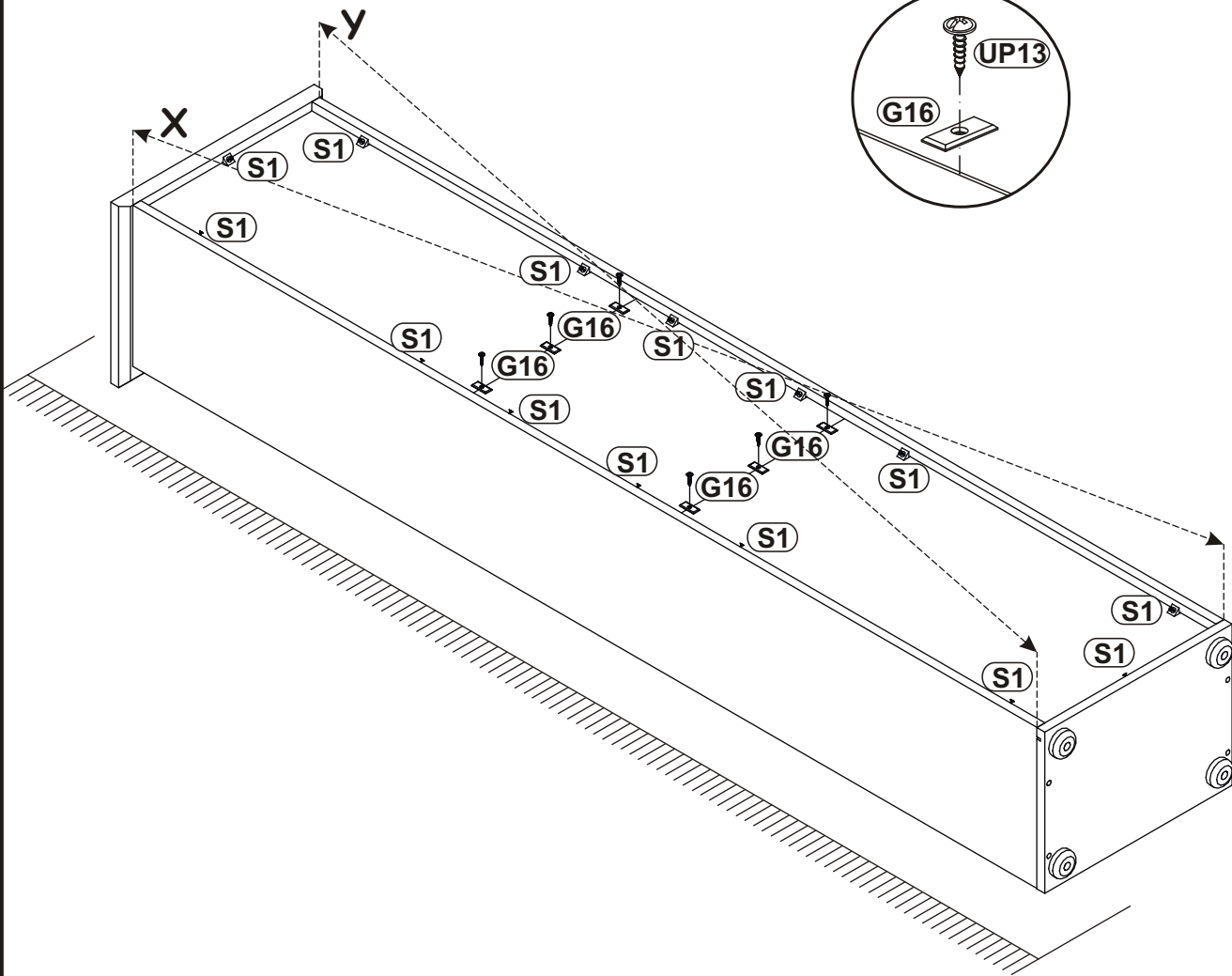
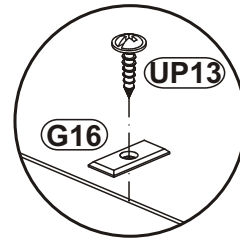
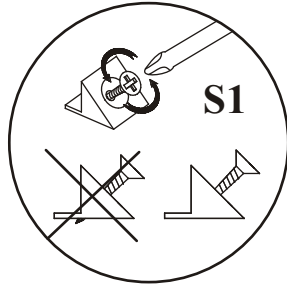

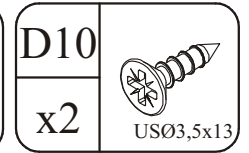
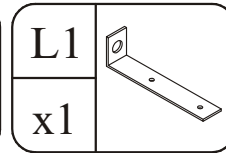
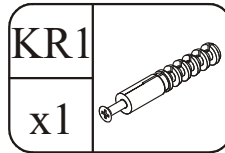

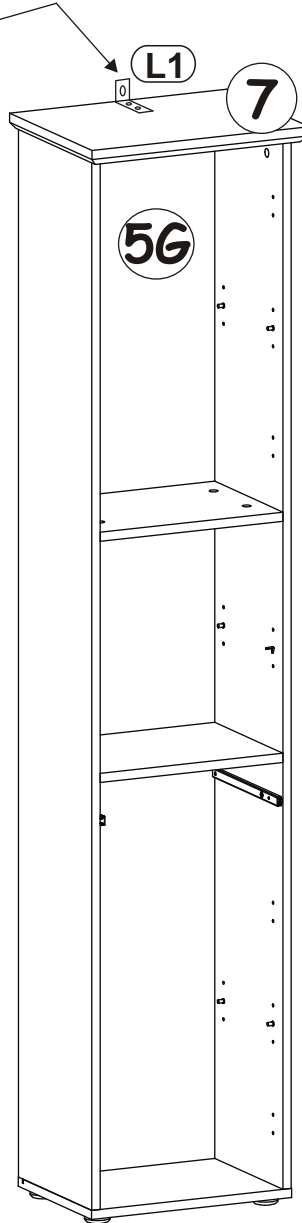
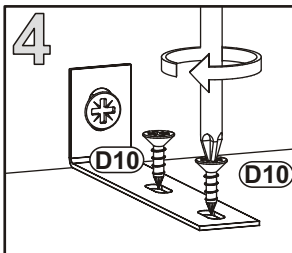
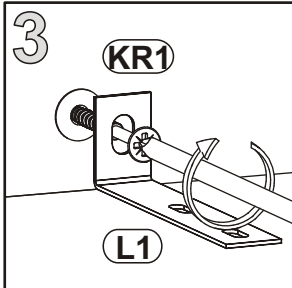
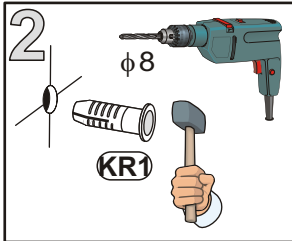
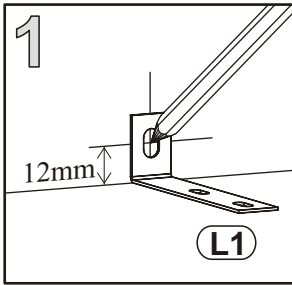
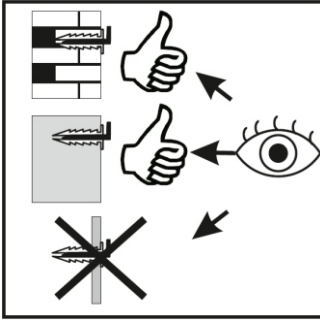

16

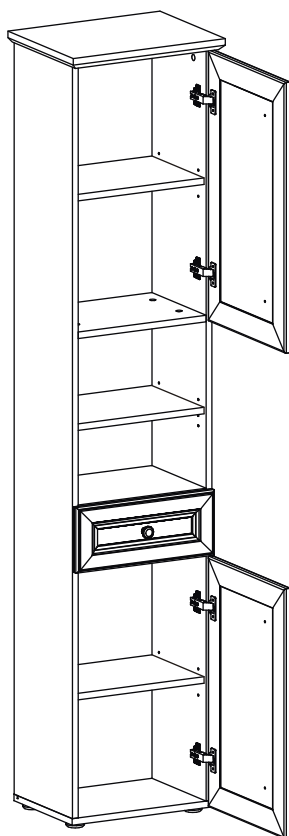

17-20



21-24

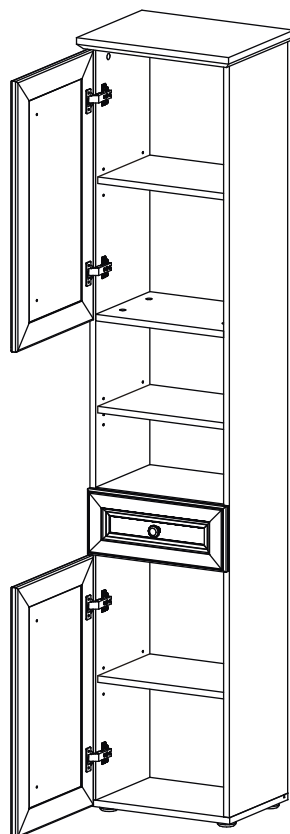

17

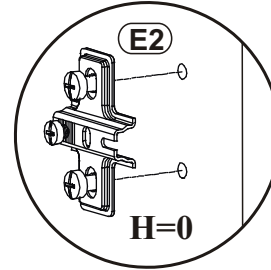
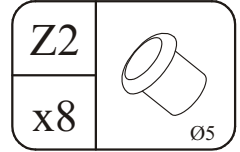
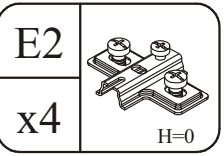
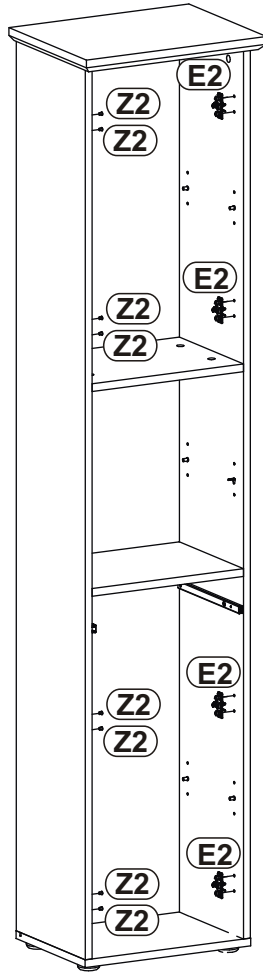
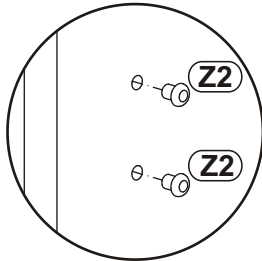

18

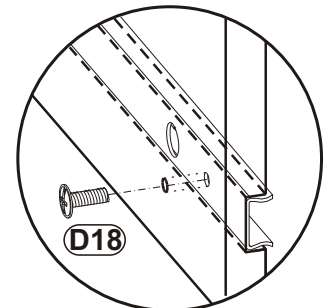
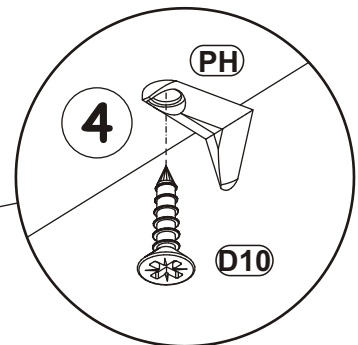
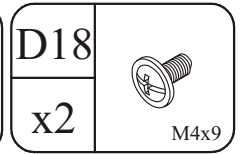
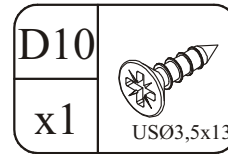
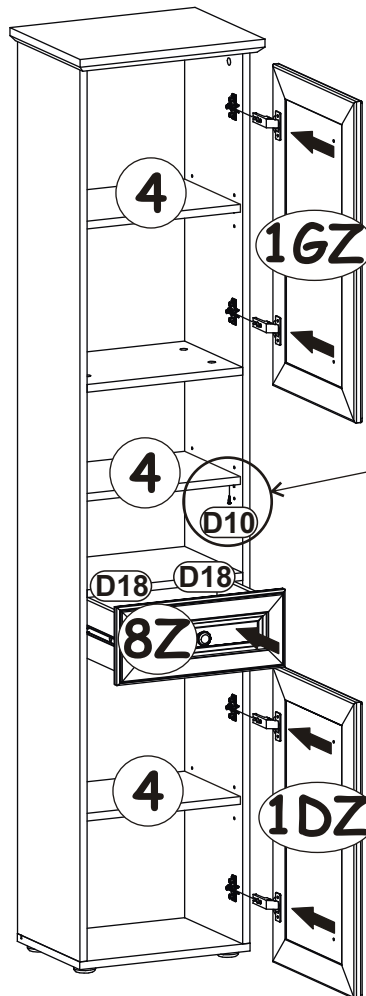
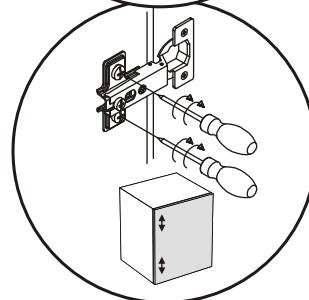
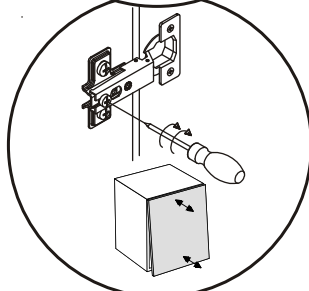
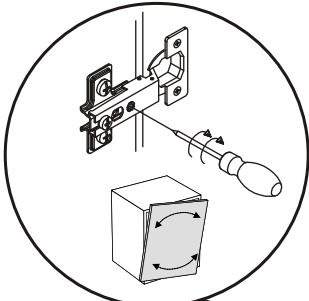

19

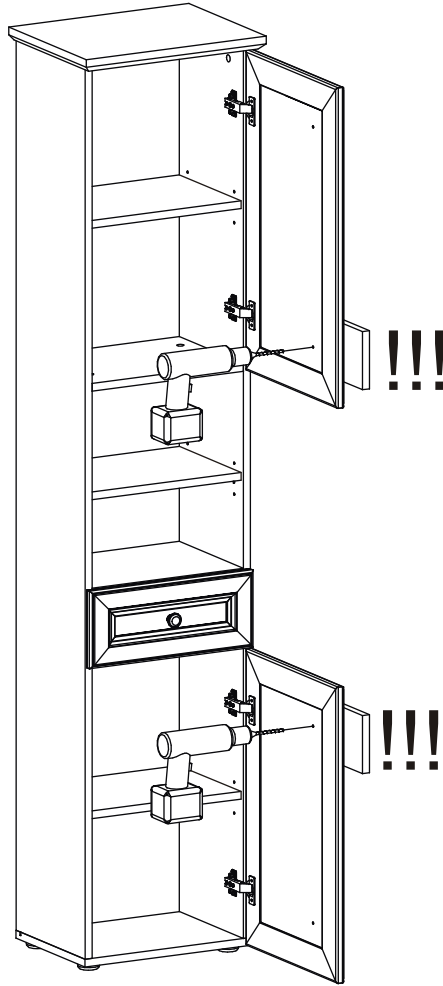

20

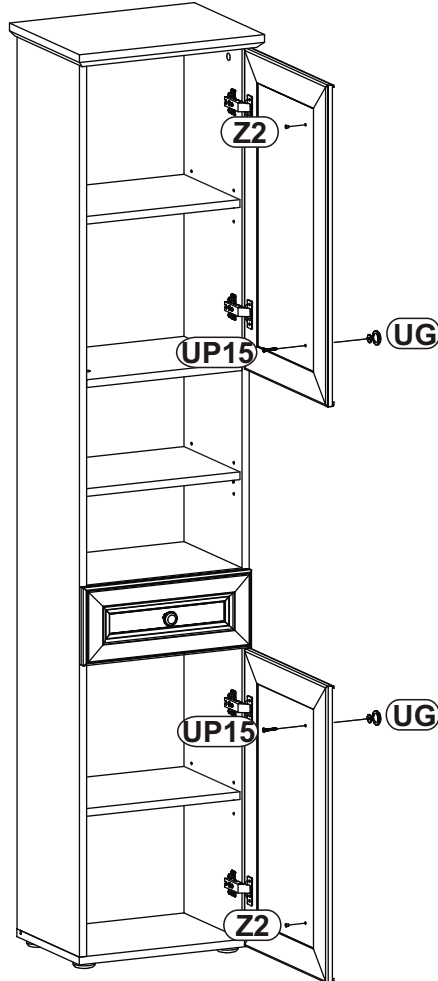
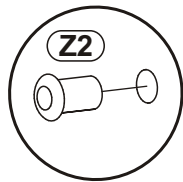

| | |
|------|---------|
| UG | |
| x2 | |
| UP15 | |
| x2 | UPØ4x25 |
| Z2 | |
| x2 | Ø5 |

21

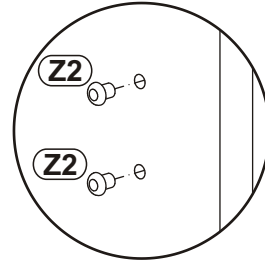
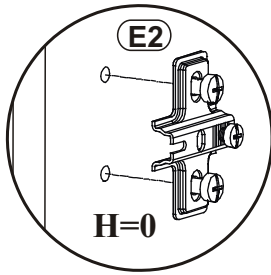
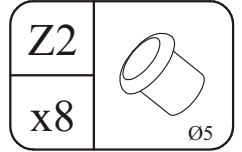
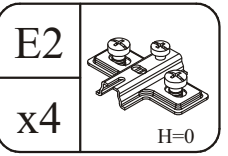
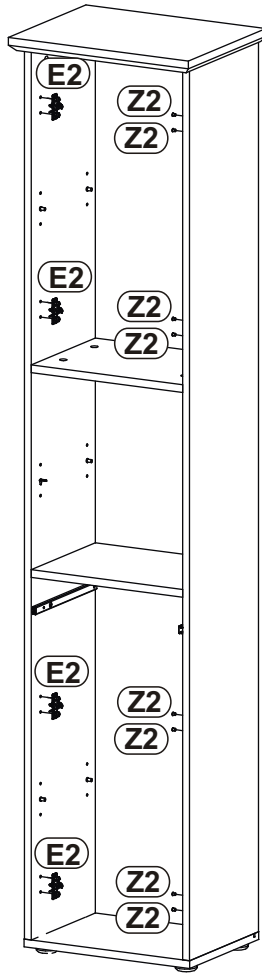

22

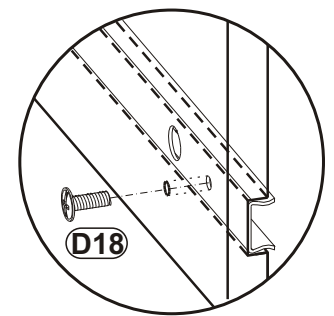
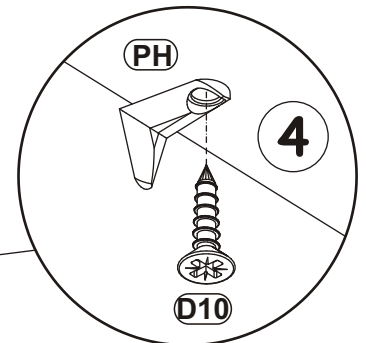
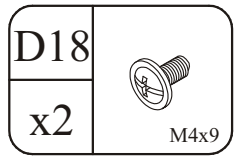
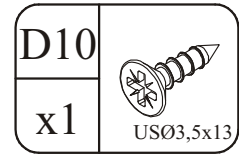
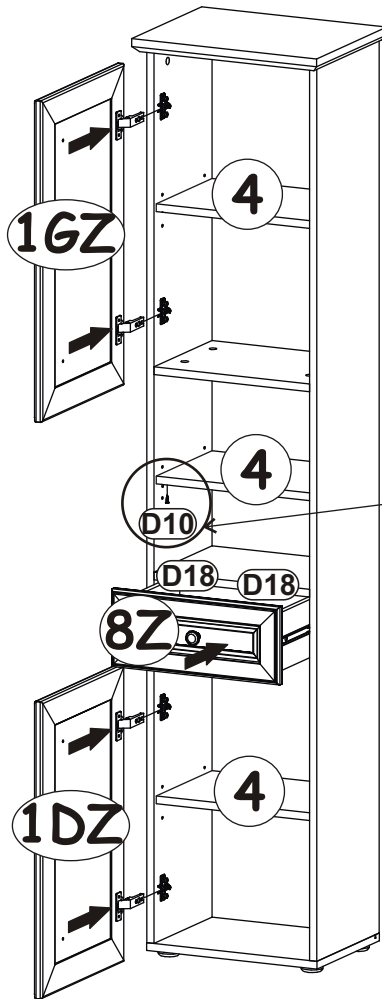
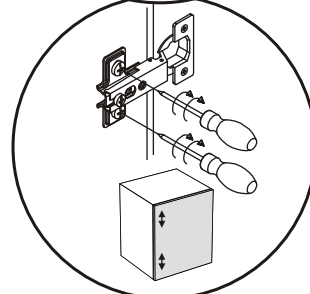
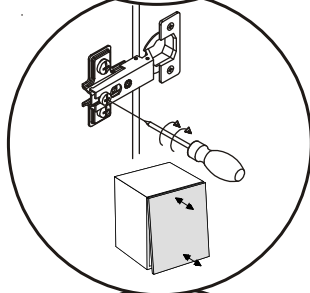
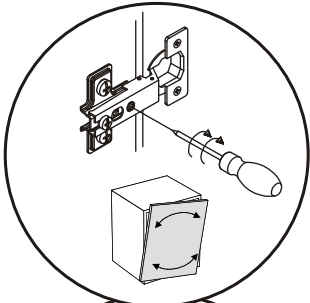

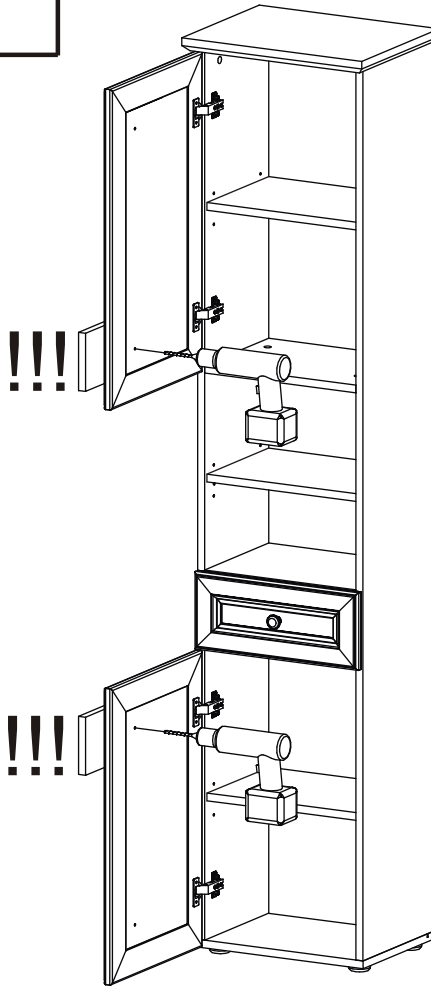

23

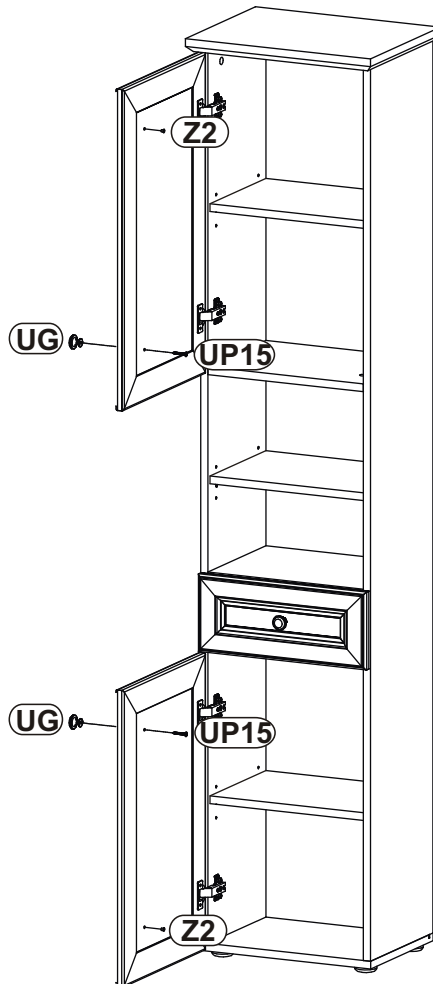
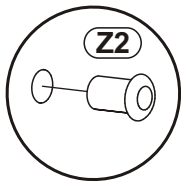

24



| | |
|------|---|
| UG |  |
| x2 | |
| UP15 |  |
| x2 | UP04x25 |
| Z2 |  |
| x2 | Ø5 |