

# JANA T / JANA II T

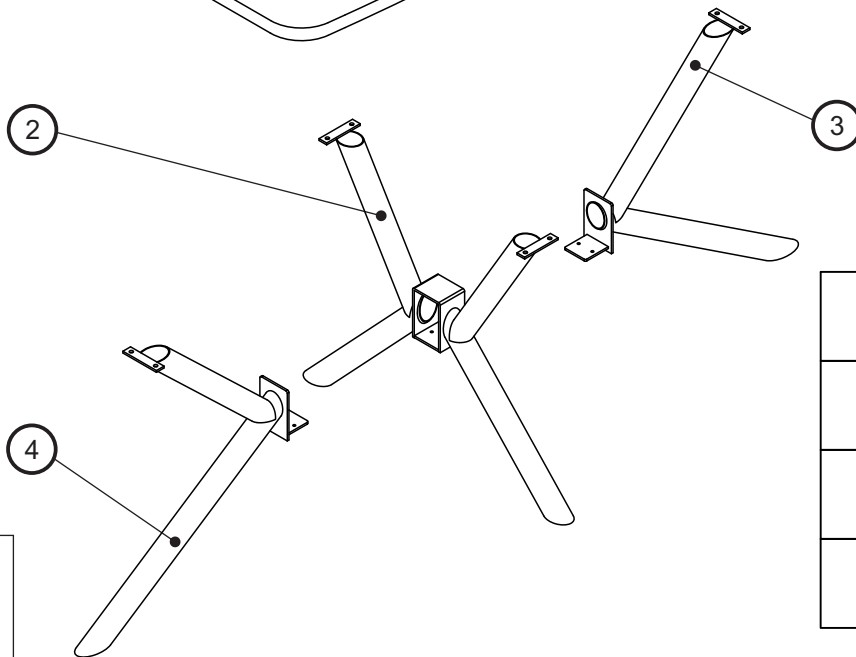

1	1X	1/2
2	1X	2/2
3	1X	2/2
4	1X	2/2

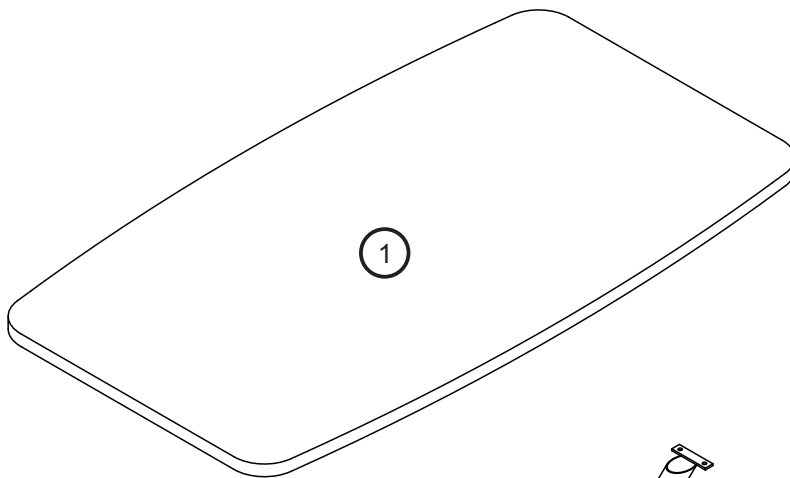
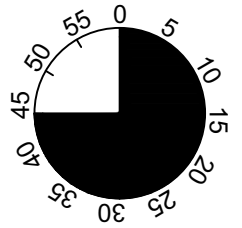
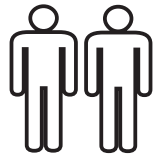
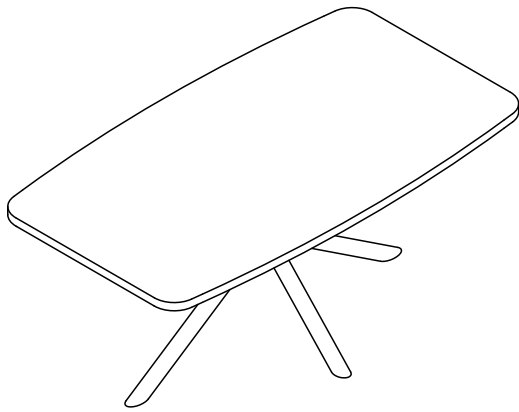
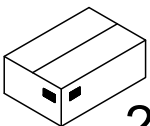

2/2

<b>A</b>	M8x25	<b>B</b>	M8x16	<b>C</b>	Ø17xØ8x1,5	<b>D</b>	Ø15xØ8x2,3	<b>E</b>	M8x12,5	<b>F</b>	5MM
	2x		8x		10x		2x		8x		1x
<b>G</b>	8MM	<b>H</b>	Ø34xM8								
	1x		4x								

I.

1.

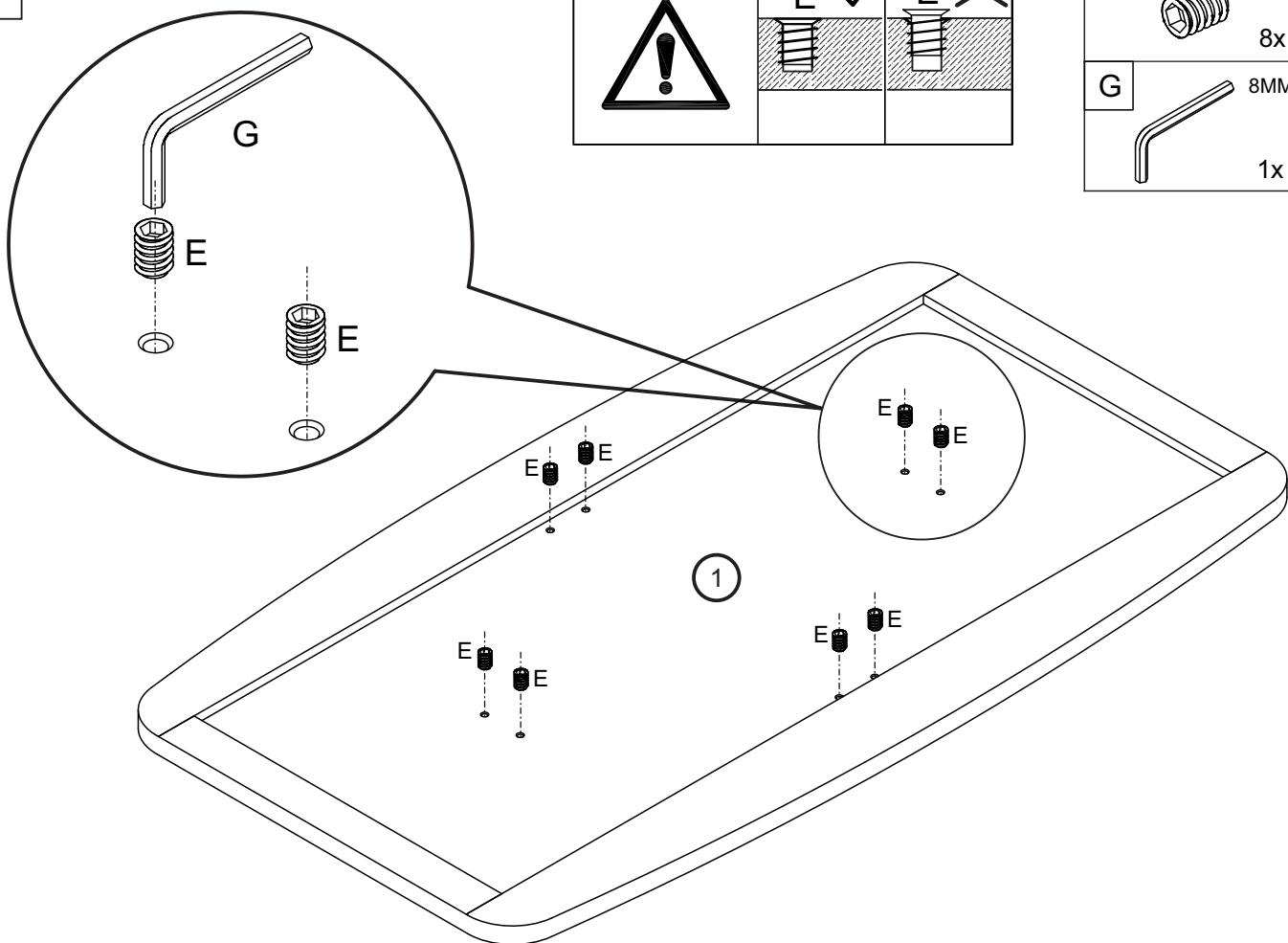



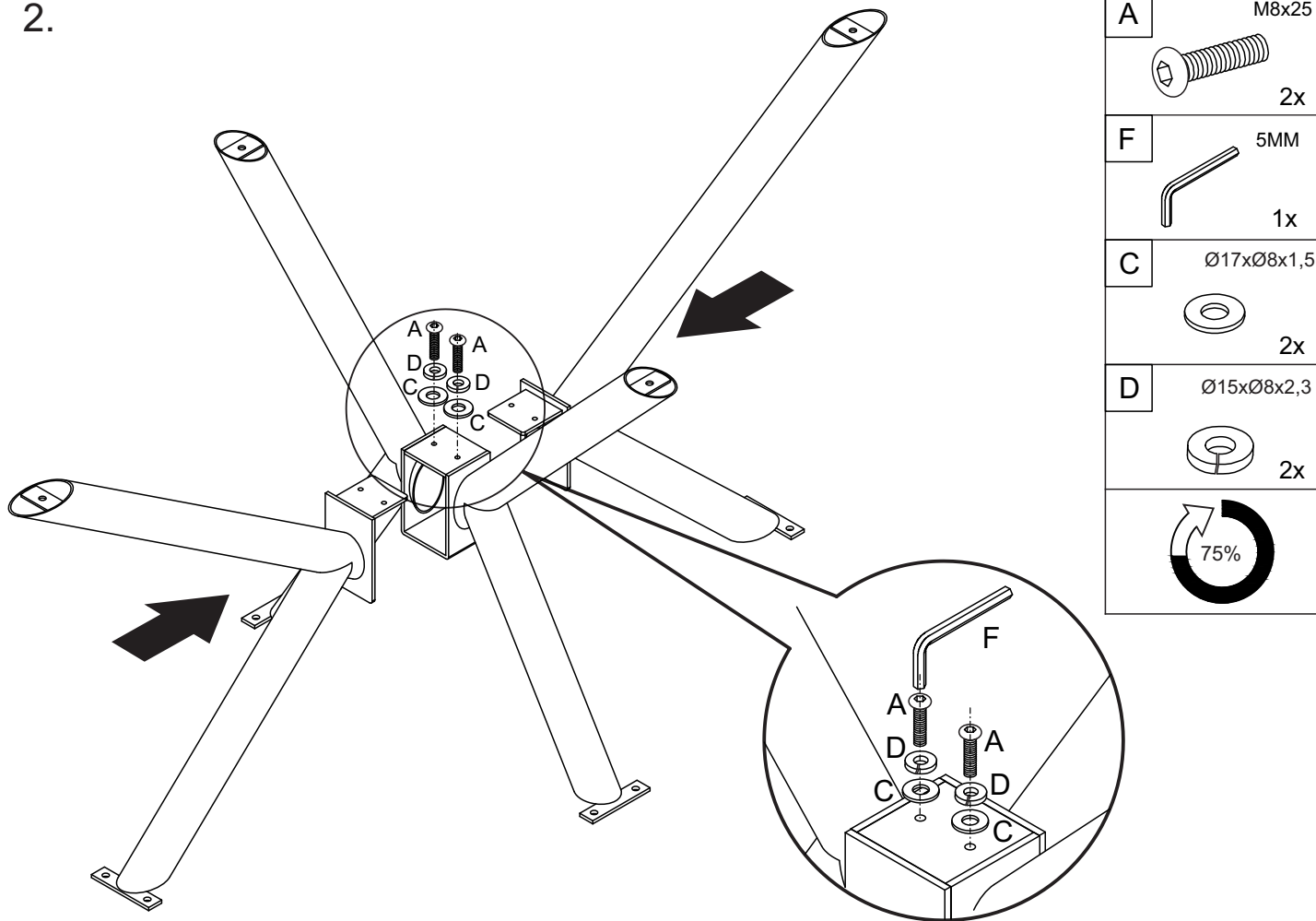

2.

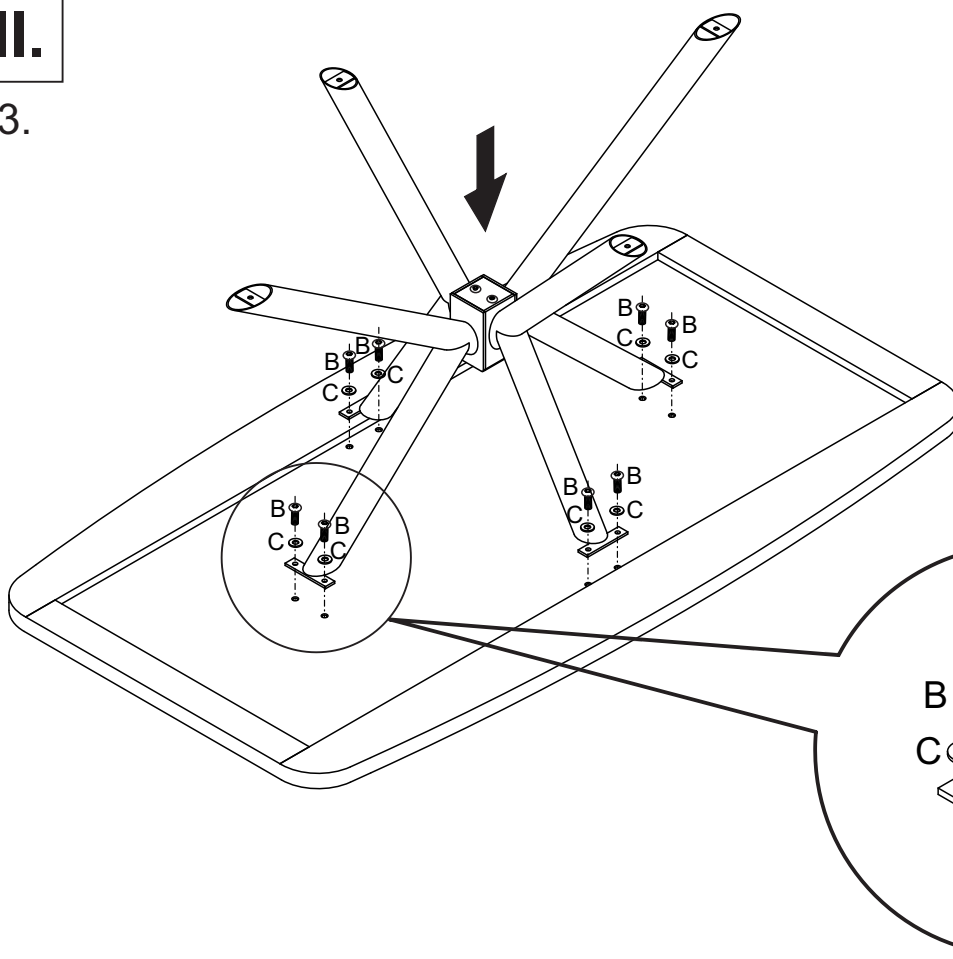

II.

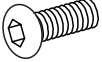

3.

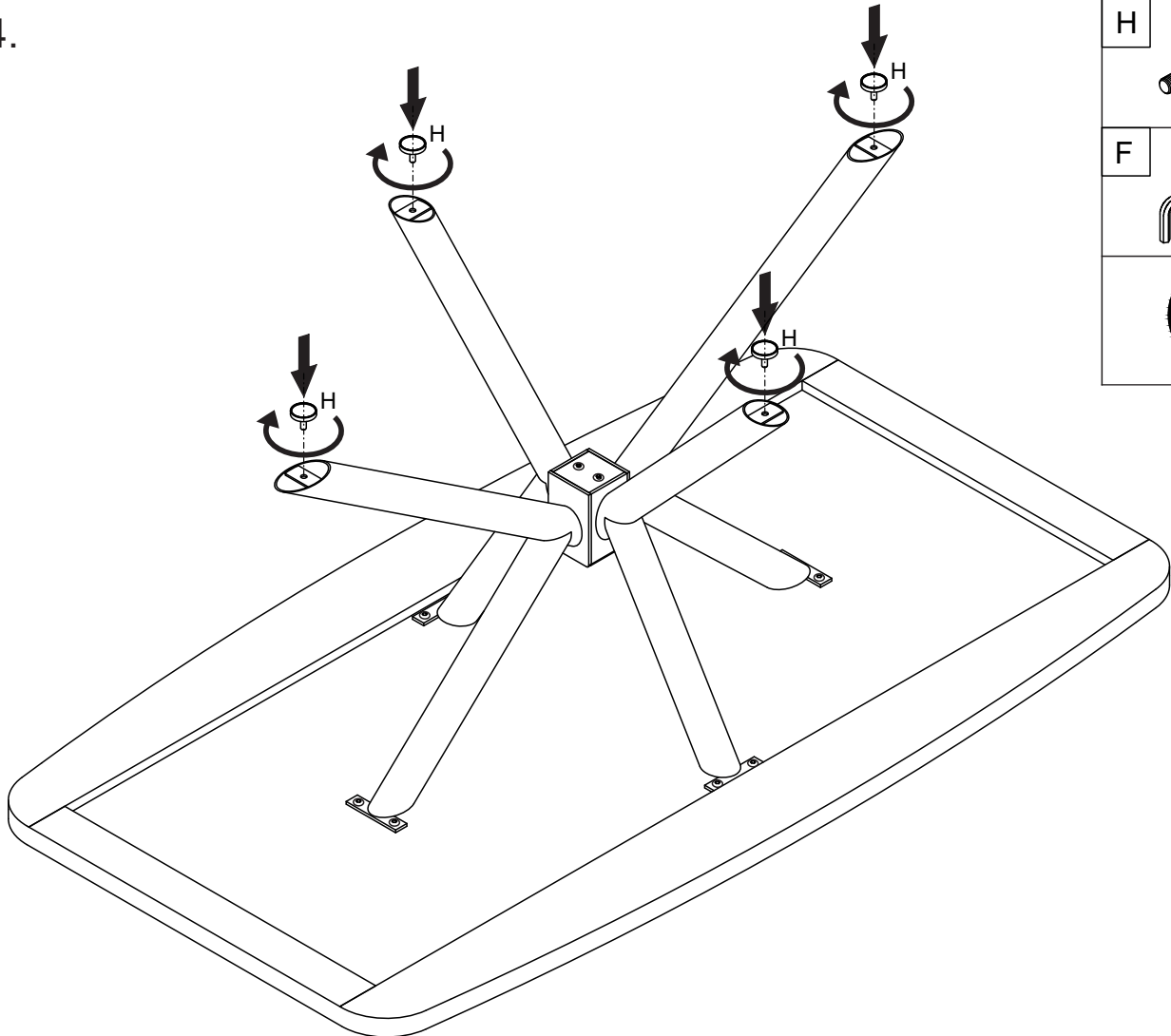

B	M8x16
	8x
F	5MM
	1x
C	Ø17xØ8x1,5
	8x
	

4.



H	Ø34xM8
	4x
F	5MM
	1x
	

III.

5.

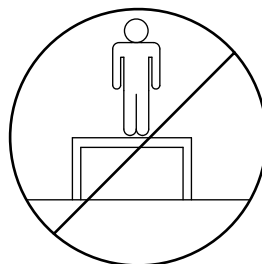
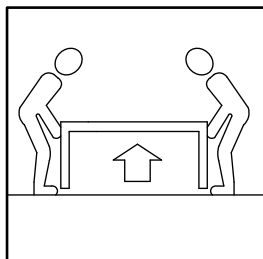
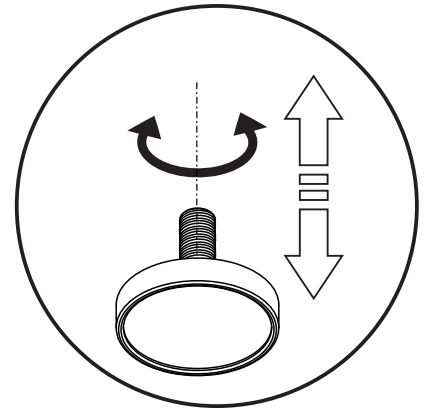
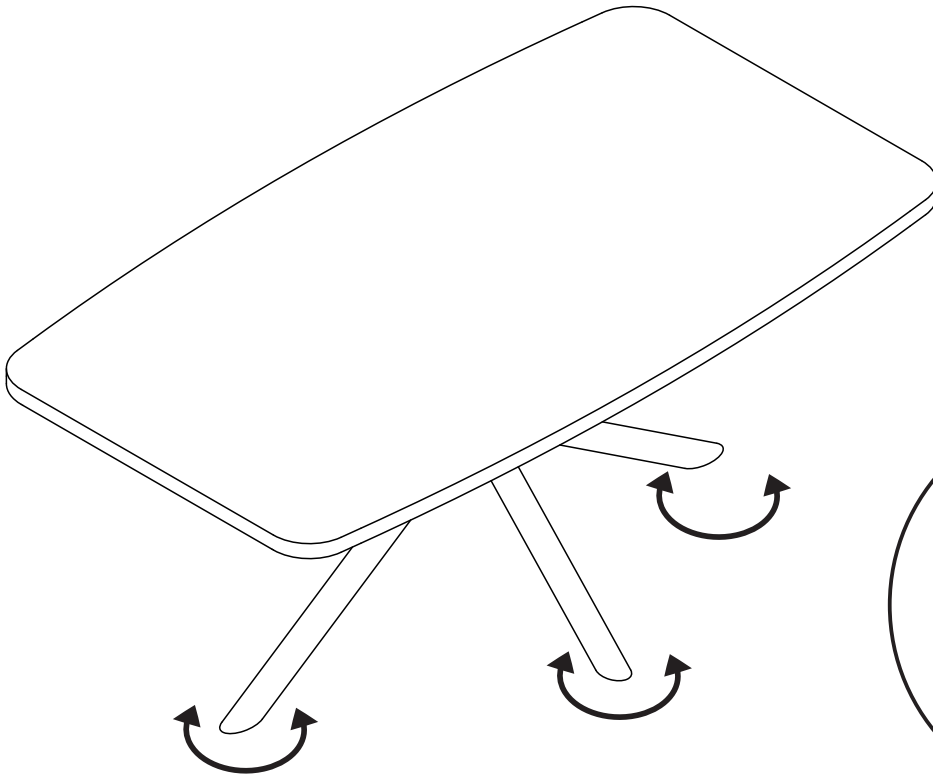
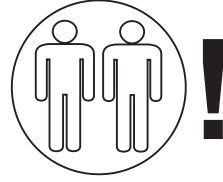
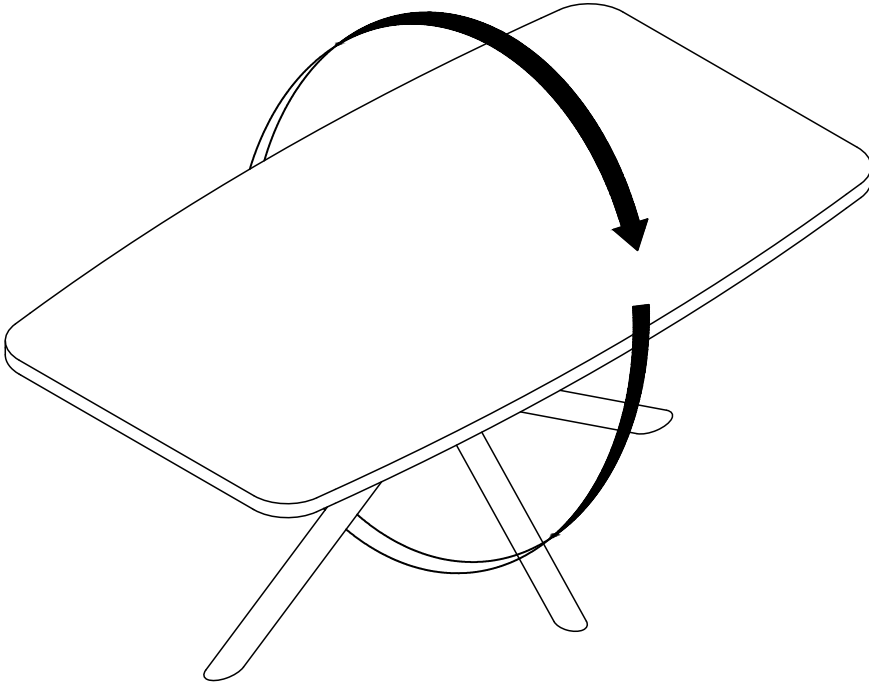

Séparez les éléments avant de trier